



## Features

- Hands-free usage increases hygiene
- Sensor positioned underneath the spout head for more accurate user detection
- WATER SAVING
- ECO CAP Technology:  
TOTO aerated bubble technology adds air to the water to achieve full water jet

## Specifications

Flow Rate: 1.3L/min  
 Water Pressure: 0.05MPa ~ 0.75MPa  
 Finish: Nickel Chrome

## Parts description

- TLE27001T-AC  
 (AC220~240V)
1. TLE27001\* (Deck-mounted)
  2. TLE01501T (AC Operated Controller)

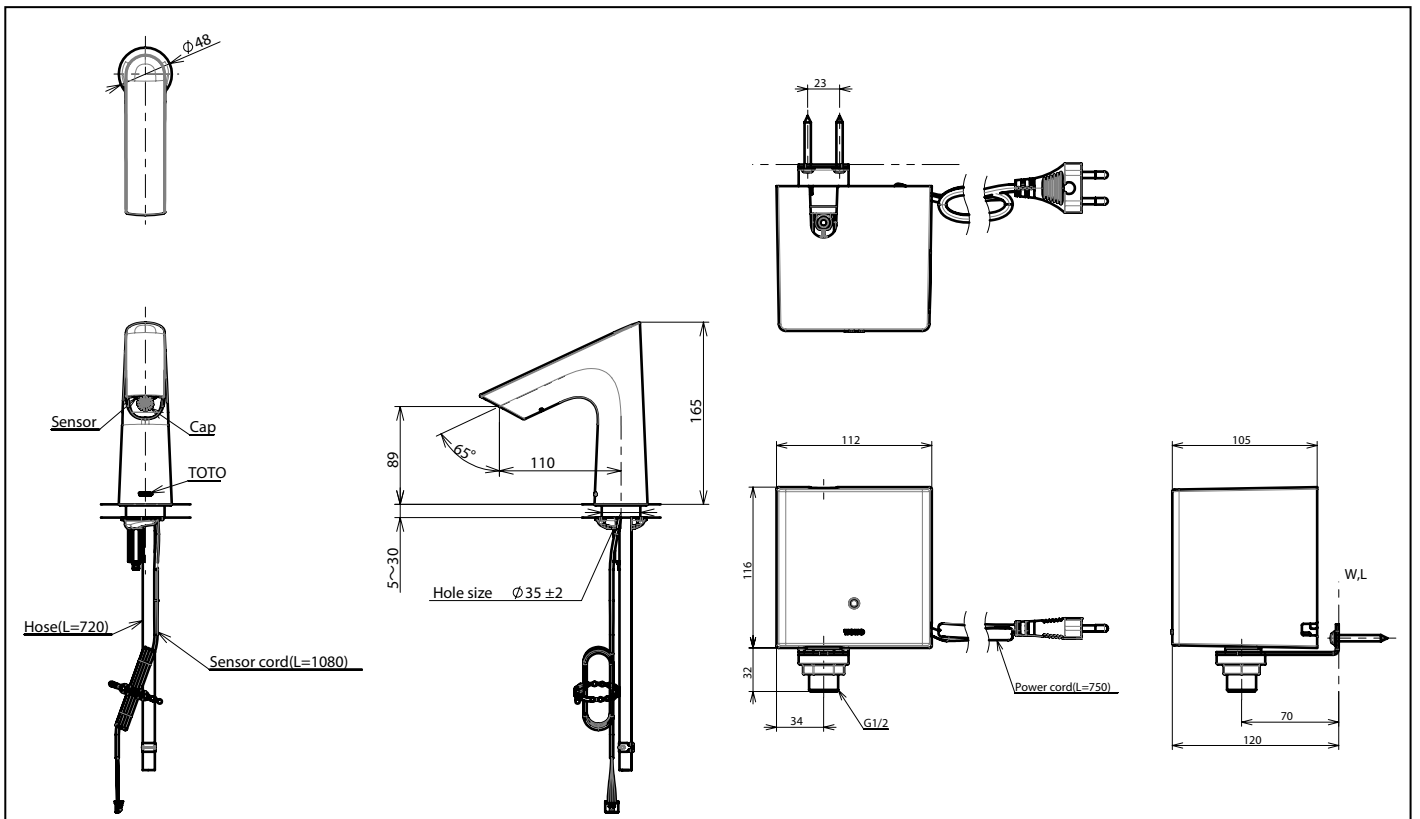

*Remarks: Please result TOTO sales representative for detail.*