

Hand Rail



Features

- Highly resistant to scratches and stains
- Requires less maintenance
- Ideal for use in public areas
- Essential for handicap toilet
- Movable function gives more convenience

Specifications

Size : 700 x 150 mm (Ø 34)

Material : Stainless Steel

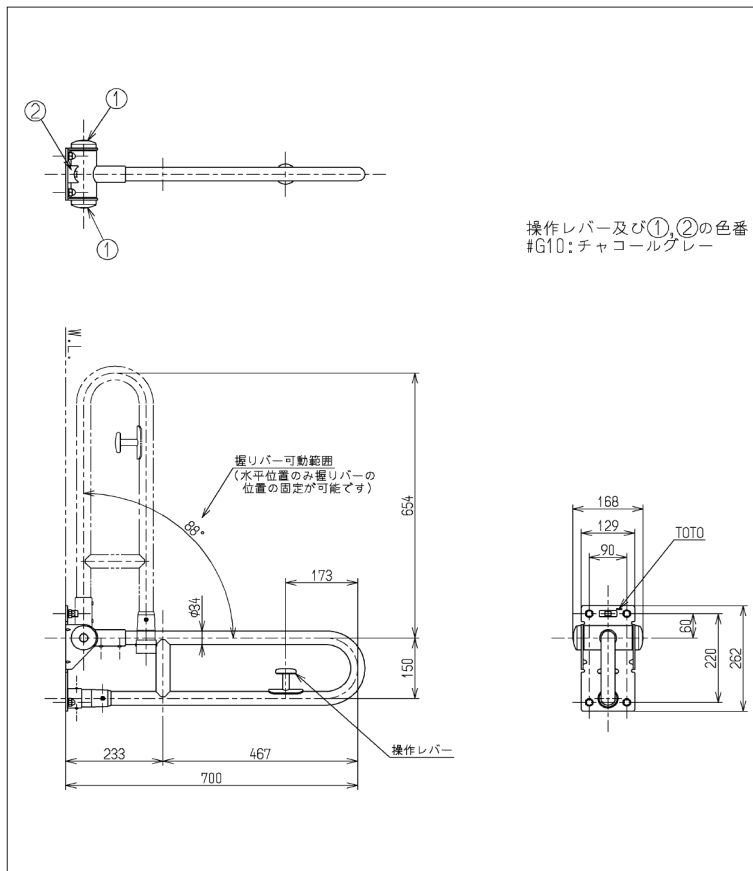

Parts Description

- **T113HK7R**
Handrail

Please consult a TOTO representative for details